

3D Printing Reference Guide

Fall 2023

The
Creative
School

**Design +
Technology LAB**



Table of Contents

3D Printing General Overview	3
FDM Printing	5
FDM Slicing Software	6
Getting Started with Cura	7
FDM Print Settings	8
Estimating FDM costs in Cura	9
FDM Quality vs Speed	10
Low Resolution/Fast Print	11
High Resolution/Slow Print	12
FDM Supports	13
SLA Printing	14
SLA Slicing Software	15
SLA Print Settings	16
SLA Printability	16
Estimating SLA costs in PreForm	17
SLA Quality vs Speed	18
Low Resolution/Fast Print	19
High Resolution/Slow Print	20
SLA Supports	21
SLS Printing	22
SLS Slicing Software	23
SLS Print Settings	24
SLS Printability	24
Estimating SLS costs in PreForm	24

3D Printing

General

Overview

Welcome to the wonderful world of 3D printing! In this document, you will find information about **3D file preparation, printing specifications** and **best practices**.

What is 3D Printing?

3D printing is an additive manufacturing process that creates physical, three-dimensional objects using digital 3D models. These objects are often made with thermosoftening plastics or UV sensitive resins. The material is added to a platform layer by layer, resulting in the form of the object.

There are 4 Basic Steps with all 3D Printing Processes:

1. Get an .STL Model

Most 3D Prints are modelled using Computer Aided Design software; there are many software options for all levels of modelling experience. Alternatively, you can use open source models from online libraries like [thingiverse](#) or [printables](#). Once an object has been modelled with all design considerations, **export** your 3D model as an .STL file. [See our tutorial documents](#) for exporting the STL in your preferred software. Submit to the [D+TL 3D Printing Services Google Form](#) for processing.

2. Select a Printing Process

A model's structural properties, intended use, print time and material preference often determines the print process. The timeline and material offerings of the two print processes have its advantages and disadvantages.

The Design + Technology Lab supports three different 3D printing processes:



Example of an FDM-printed dinosaur

FDM (thermosoftening filament extrusion) printing uses spools of PLA plastic filament. A spool of filament is fed through a heated nozzle and strategically layered to form the shape of the model.



Example of an SLA-printed dinosaur



Example of an SLS-printed dinosaur

SLA (vat polymerization) 3D printing uses resin which is cured with UV-light. A tray of UV-sensitive resin is hardened layer by layer onto a platform using a laser.

SLS (nylon powder fusion) printing uses a laser to fuse together nylon powder to create a solid 3D print without the need for supports.

3. Assign Print Settings

Assign print settings to your STL with a separate “slicing” software, such as [Cura](#) for FDM prints, or [Preform](#) for SLA and SLS prints. **Slicing** refers to the conversion of an .stl file to .gcode. An .stl file holds structural properties of the three-dimensional model, while .gcode translates these properties into strategic pathways for a printer to execute. These pathways are aligned with the printer's parameters and are formatted using a combination of X, Y and Z coordinates.

4. Printing the Model

After a model has been prepared, sliced and approved by a D+TL Technician, it is assigned to one of our printers. During its initial layers, the platform manually adjusted to ensure a successful print. This process is referred to as levelling.

[Take a look at the Lab's 3D printing detailed video of file setup for 3D printing.](#)



A 3D Printed Articulated Kuka Robot arm.

FDM Printing

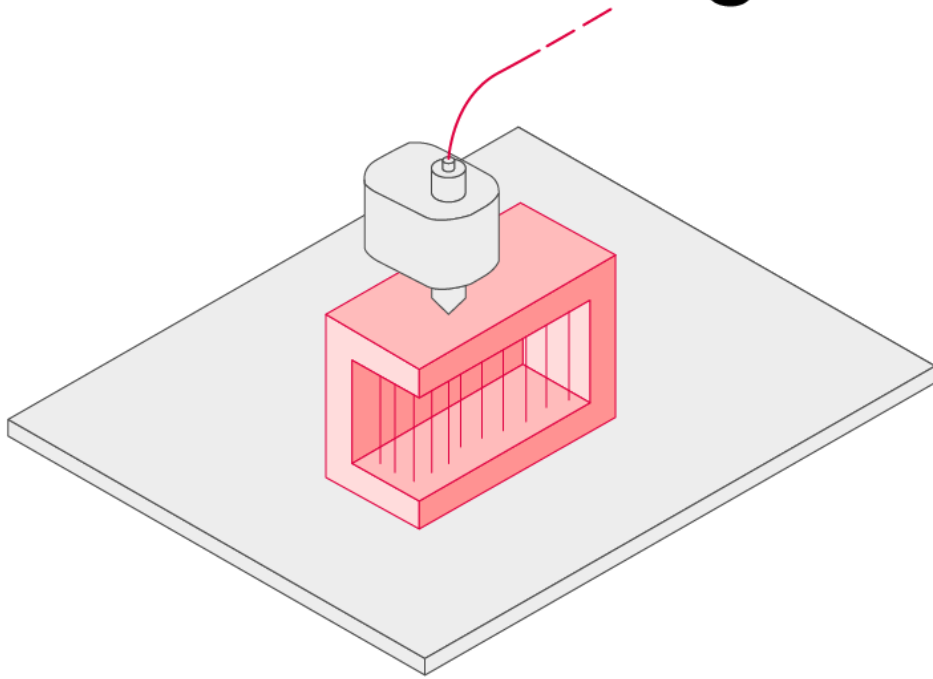

FDM Slicing Software

A **3D slicing software** is the in-between step after modeling and before printing. The slicer interprets the STL's array of polygons into printable, layered toolpaths (toolpaths = specific locations where the machine travels and does its thing). The slicing software can estimate the **duration of 3D printing time** and the **amount of material** that will be used.

The Design + Technology Lab's recommended slicer for FDM printing is [Ultimaker Cura](#) (it's free, so you can download it, too!).

Previewing your prints with a slicer allows you to get helpful information, such as:

- Quantity of detail: the vertical thickness of each layer of the model being printed
- Where support material will be applied to ensure the adherence of model(s) to the platform and overall success of prints.
- Time required to complete the print
- Areas that will be too thin to print successfully (details smaller than 1mm may not print cleanly)
- Object scale (The maximum printing volume of the Lab's FDM printers is 355 x 355 x 355mm)
- The orientation of your object in relation to the print "grain" (see page 8: Layer Thickness)
- "Printability" errors with your model

Getting Started with Cura

Ultimaker Cura is a free slicer **for FDM prints**. Upon [downloading the software](#), it will ask you to Create an Account, this is optional and can be skipped using the icon at the bottom right of the page.

Under the Add a Printer Menu, select Add a Non-Networked Printer. A menu will appear with printer models. The Lab uses a printer called "**Artillery Sidewinder X1**".

[Click here for full Cura tutorial.](#) (←Skip to section 3: Cura 3D Quick Start Guide)

In the top right side of the main Cura interface, you'll find a drop-down menu for different print settings. This is where you'll get to define the material quality of your print.

To explain some of the setting options, let's take a look at the pertinent parts of the printer and printing process.

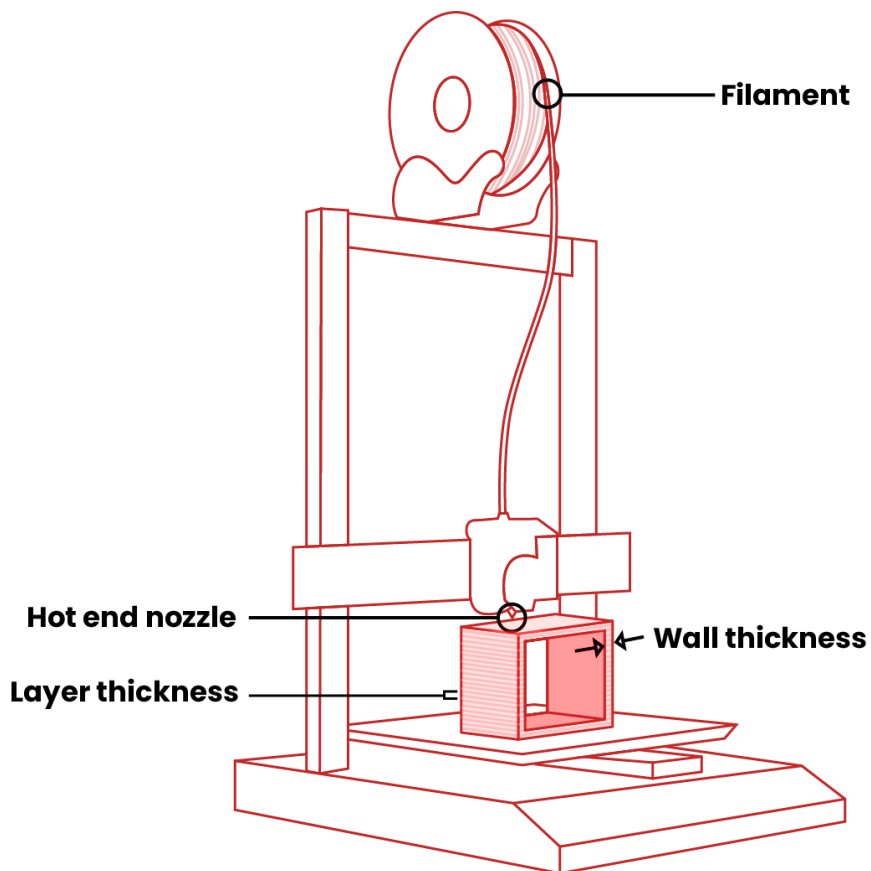

Simplified diagram of an FDM 3D printer

Filament: The PLA plastic filament at the Lab is 1.75mm in diameter. The filament diameter does not impact the print quality.

Hot end nozzle: The hot end nozzles at the Lab have a diameter of 0.4mm. This dictates the thickest possible layer height.

Layer thickness: The layer thickness or layer height refers to the height of each layer in mm.

Wall thickness: The wall thickness refers to the thickness of the surface of the printed object.

FDM Print Settings

Layer thickness or height refers to the height of each layer in mm. Higher values produce faster prints in lower resolution, lower values produce slower prints in higher resolution. The layer thickness/height can span anywhere from 0.05mm to 0.4mm, though it is recommended to be between 0.12mm - 0.22mm.

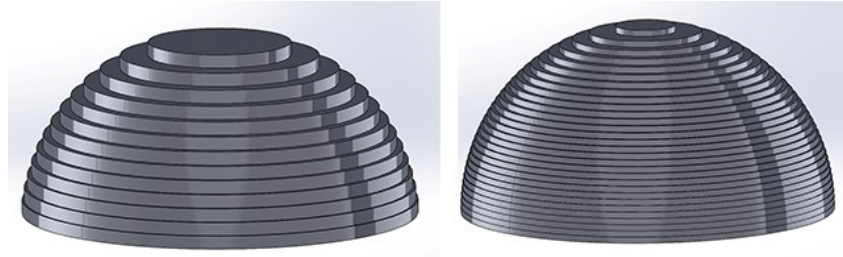

3D printers build up prints in a series of thin *horizontal* layers. Make sure you keep this in mind when orienting your model: **critical details should be oriented parallel to the build platform.**

If the object will be under pressure, it is important to consider the orientation of the “grain”, as it affects the object's strength.

Tension load normal to layers:
Part is weak

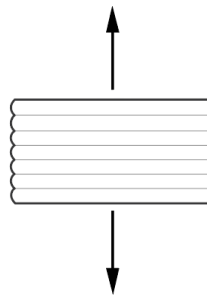

Tension load parallel to layers:
Part is strong



Wall thickness refers to the thickness of the surface of the printed object. The wall thickness has to be greater than or equal to the layer thickness, and is recommended to be a multiple of the nozzle diameter.

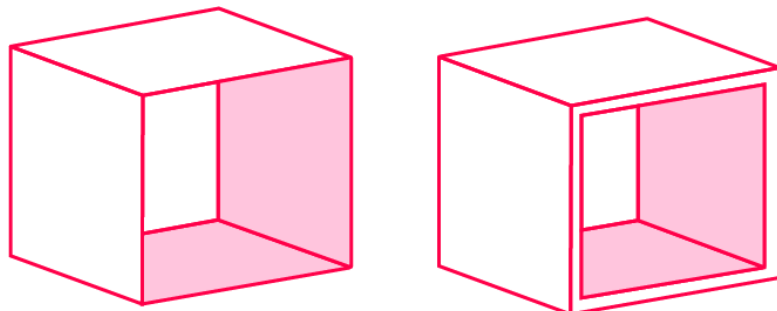

Infill is an unseen interior structure of 3D prints that plays a very important role in the overall **strength** of your model. Infill is responsible for connecting the outer shells of your 3D print. Unless otherwise specified, the Lab 3D prints with a **10% infill**.

For models that require more strength or need to be assembled with other parts, it is best to select a higher print density to ensure they can sustain enough applied forces. For projects that are for prototyping or visualization purposes, a low print density will suffice.



Estimating FDM costs in Cura

At the Lab, FDM prints are priced based on their weight. For FDM prints, the Lab charges **\$0.10 / gram** of PLA plastic.

Once you have oriented your model, added supports, assigned print quality and infill, Cura will calculate the approximate duration and weight of your 3D print.

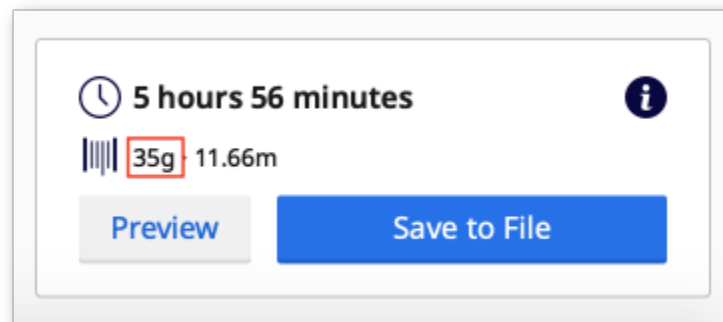

FDM Quality vs Speed

The quality of a 3D print is impacted by the **height of each layer**. You can think about print quality like the “resolution” of an image. Low resolution is more “pixelated.” High resolution is more detailed. You can read more information about the specifics below. The Lab prints with a 0.2mm layer height unless otherwise specified.

Low Quality FDM (0.2mm layers)

High Quality FDM (0.12mm layers)

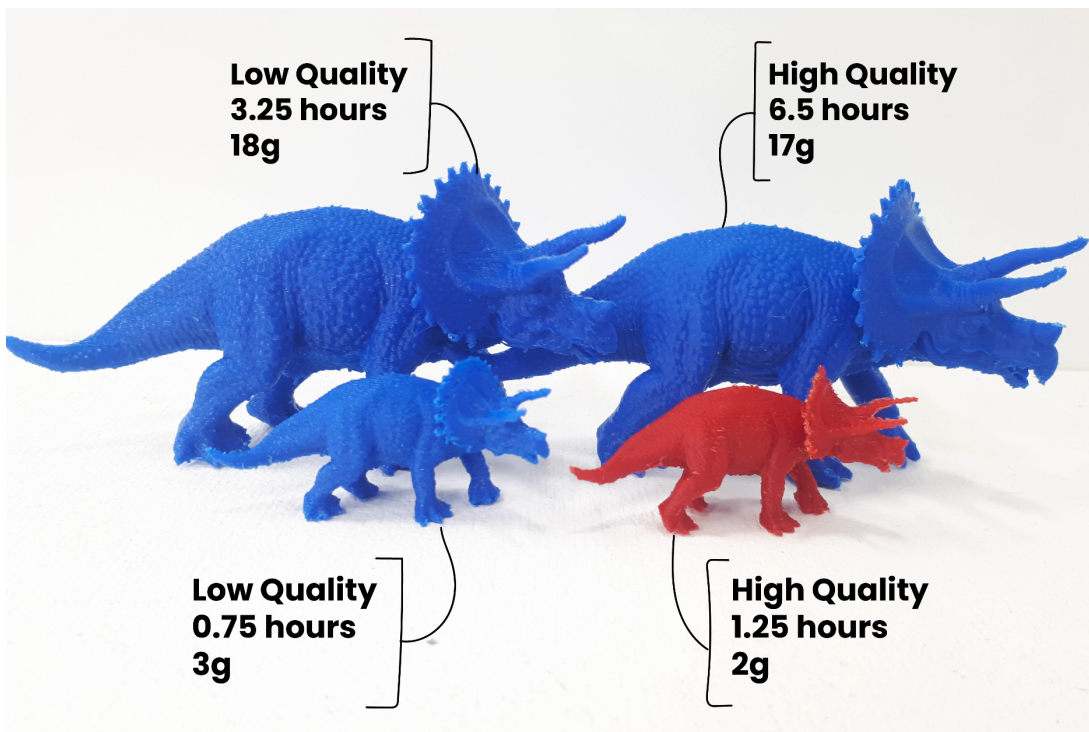

Low Resolution/Fast Print

Lower quality will print faster. Printing at a low quality increases the height of each layer of the object. This does not affect the final size of your object. Thicker layers do not allow for fine surface detail and **the layered texture is more visible**. The walls of a low quality print will be slightly thicker and use slightly more plastic.

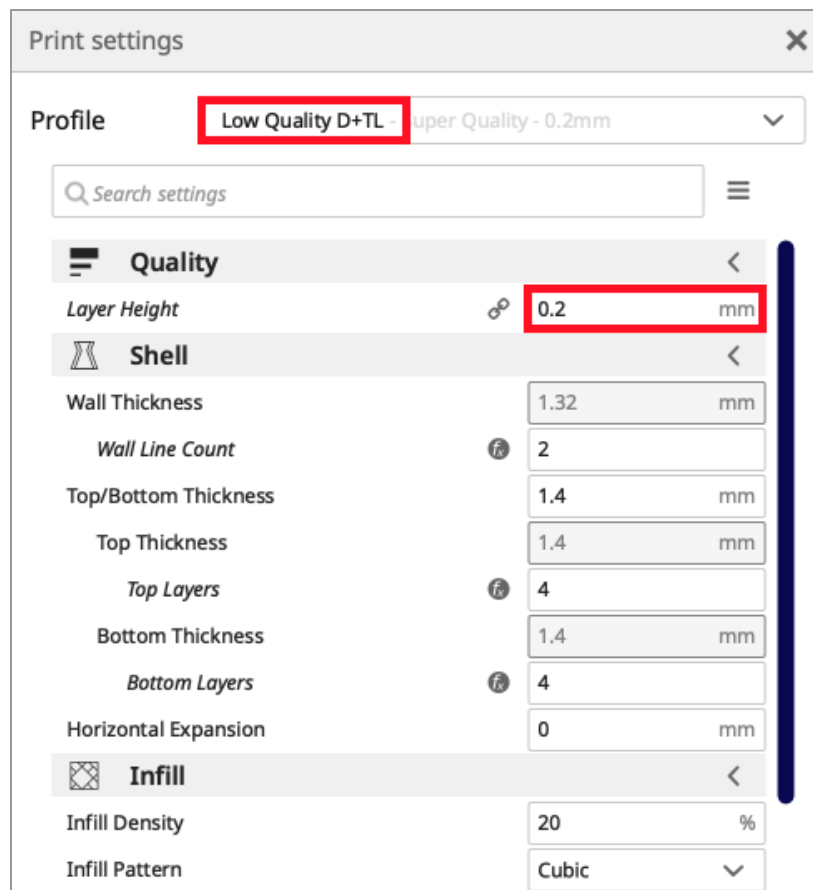

The above image shows the Lab's **FDM** print settings (in Cura) for low quality prints. The layer height is set to 0.2 mm.

High Resolution/Slow Print

Higher quality will print slower. Printing at a high quality decreases the height of each layer. This does not affect the final size of your object. Thinner layers **look smoother and can be more detailed**. The walls of a high quality print will be slightly thinner and use slightly less plastic.



Print settings
✕

Profile High Quality D+TL - Super Quality - 0.12mm

Quality <

Layer Height 0.12 mm

Shell <

Wall Thickness 1.32 mm

Wall Line Count 2

Top/Bottom Thickness 0.84 mm

Top Thickness 0.84 mm

Top Layers 4

Bottom Thickness 0.84 mm

Bottom Layers 4

Horizontal Expansion 0 mm

Infill <

Infill Density 20 %

Infill Pattern Cubic

The above image shows the Lab's **FDM** print settings (in Cura) for high quality prints. The layer height is set to 0.12mm.

FDM Supports



Flush Angle Cutters

When the plastic comes out of the printing nozzle, it is liquified and does not hold its shape well. Each new layer must be supported by the layer beneath it. If your model has an overhang which is not supported by anything below, there's a good chance it will droop. To avoid this, it is recommended to use additional 3D printed support structures called "supports".

Supports increase the material weight and duration of the print. They can cause little imperfections in the object's surface, and can be a hassle to remove.

The Lab recommends using "flush angle cutters" to help remove stubborn support material.

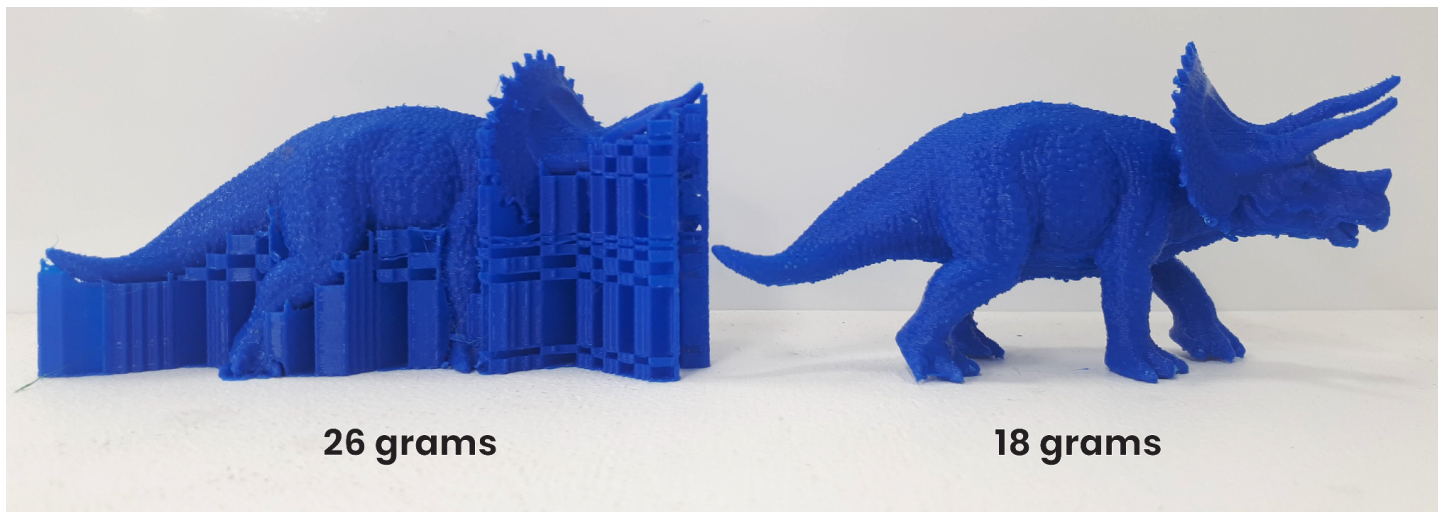

The above image compares the weight of an FDM 3D print before and after the supports are removed.

SLA Printing

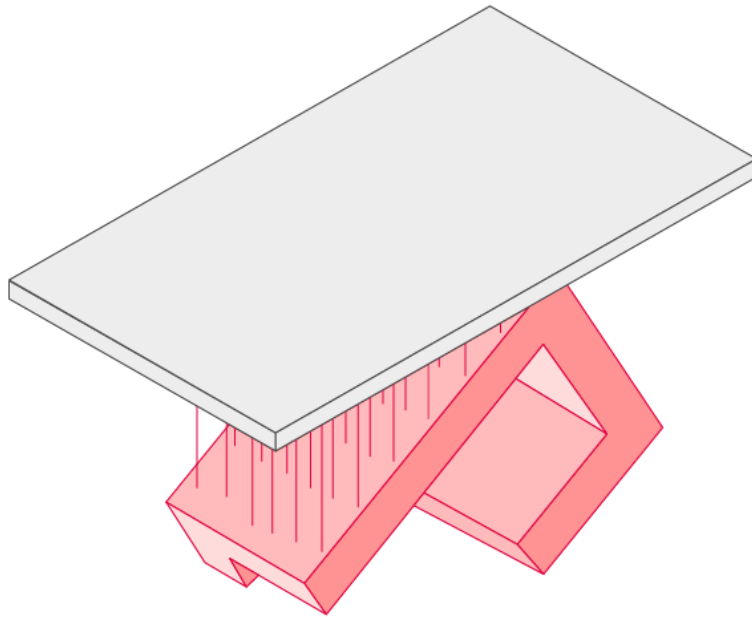

SLA Slicing Software

A **3D slicing software** is the in-between step after modeling and before printing. The slicer interprets the STL's array of polygons into printable, layered toolpaths (toolpaths = specific locations where the machine travels and does its thing). The slicing software can estimate the **duration of 3D printing time** and the **amount of material** that will be used.

The Design + Technology Lab's slicer of choice for our SLA printer is [PreForm](#). This slicer is free! The Lab encourages you to preview your SLA print in PreForm prior to printing to get helpful information, such as:

- Quantity of detail: the vertical thickness of each layer of the model being printed
- Where support material will be applied to ensure the adherence of model(s) to the platform and overall success of prints.
- Time required to complete the print
- Areas that will be too thin to print successfully (details smaller than 1mm may not print cleanly)
- Object scale (The maximum SLA printing volume is 145 x 145 x 185 mm)
- The orientation of your object in relation to the print "grain" (see page 16: SLA Printability)
- "Printability" errors with your model

SLA Print Settings

Although FDM printing is cheaper and the preferred process for most models, the SLA printing technology offers a much higher print resolution quality than its counterpart.

When printing using SLA technology, each consecutive layer is hardened as a solid layer. This means that the final overall 3D printed object is completely solid on the interior: there are **no wall thickness or infill settings**. This makes the slicing process more straightforward, compared to FDM.

Applying print settings in PreForm is as simple as:

1. Choosing the printer type (the Lab uses **Form 3** for SLA)
2. Choosing the resin type (either clear standard, white standard, or castable wax resin)
3. Selecting your preferred layer thickness (see pages 19–20)
4. Apply auto-generated support structures (see page 21)

If you want to print a hollow model, you can use a mesh-editing software to [hollow-out your .STL file to print a shell only](#). This saves on unnecessary material cost.

SLA Printability

Check out [this article](#) for helpful SLA design tips!

3D printers build up prints in a series of thin *horizontal* layers. Make sure you keep this in mind when orienting your model: **critical details should be oriented parallel to the build platform**.

Due to the physical nature of SLA printing, there is often the chance of your print “suction cupping” against the resin tank. This phenomenon **occurs when there is a cavity or hollow portion** of your object.

To avoid “suction cupping”, use a 3D design software to either fill the hollow or add drainage holes to minimize suction during printing.

Estimating SLA costs in PreForm

When a model is imported and support structures added, you'll be able to see the time and material details of your print. These details can be used to estimate the cost of your print (explained below).



A screenshot of a software interface showing a 'DETAILS' panel. The panel has a title 'DETAILS' with a downward arrow. Below the title are three items, each with a blue icon and text:

Icon	Text	Value
🕒	Print Time	~ 7 h
📄	Layers	885
📦	Volume	98.60 mL

At the Lab, SLA prints are priced based on their weight. For SLA prints, the Lab charges **\$0.40 / gram** of standard resin, and **\$0.80 / gram** of castable wax resin. The PreForm software calculates the volume (mL) of resin that will be printed. Formlabs **resin weighs approximately 1 g/mL**. You can use that approximation to estimate the print's total weight.

SLA Quality vs Speed

The quality of a 3D print is impacted by the **height of each layer**. You can think about print quality like the “resolution” of an image. Low resolution is more “pixelated.” High resolution is more detailed. You can read more information about the specifics below. The Lab offers three quality options for 3D printing: Low, Medium and High quality.

Low Resolution SLA (supports removed)

High Resolution SLA (with supports)

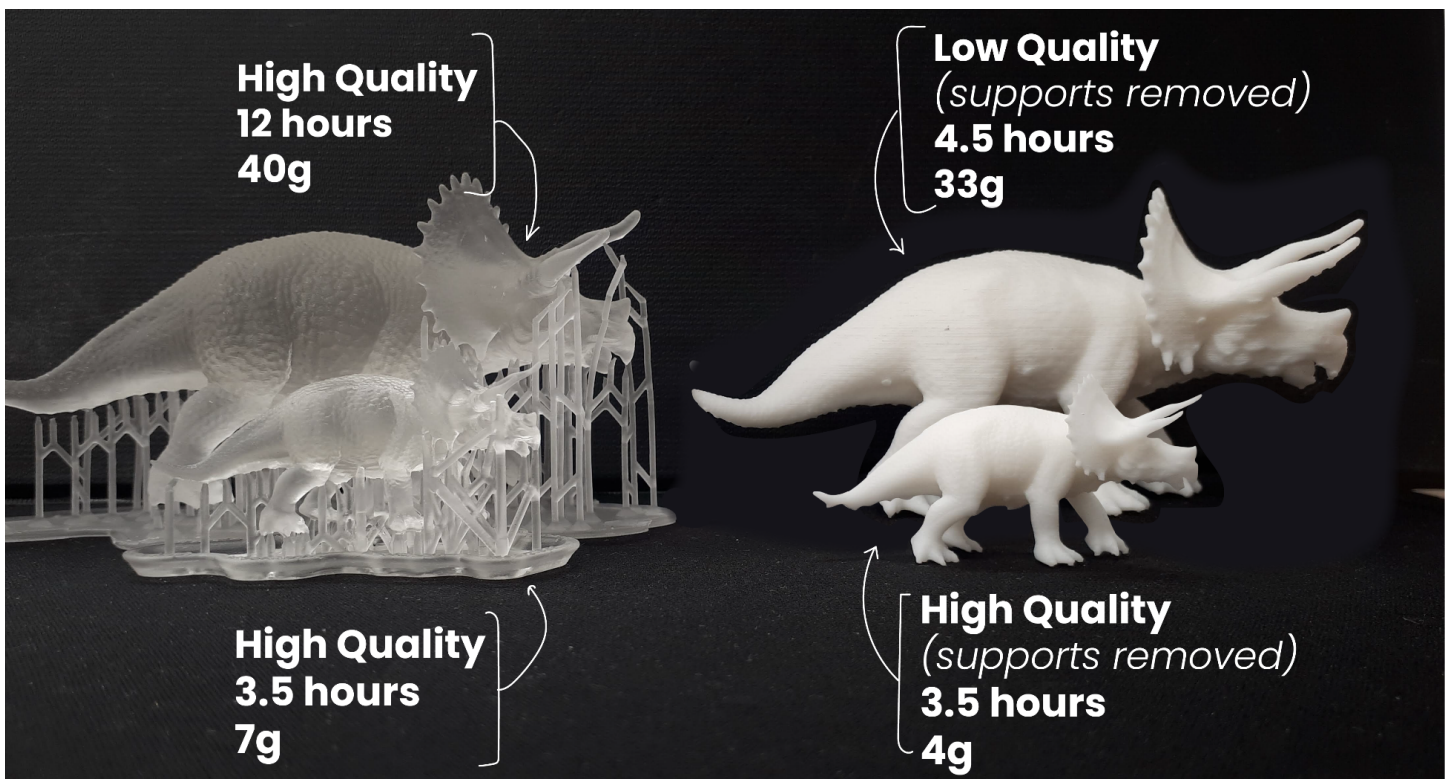
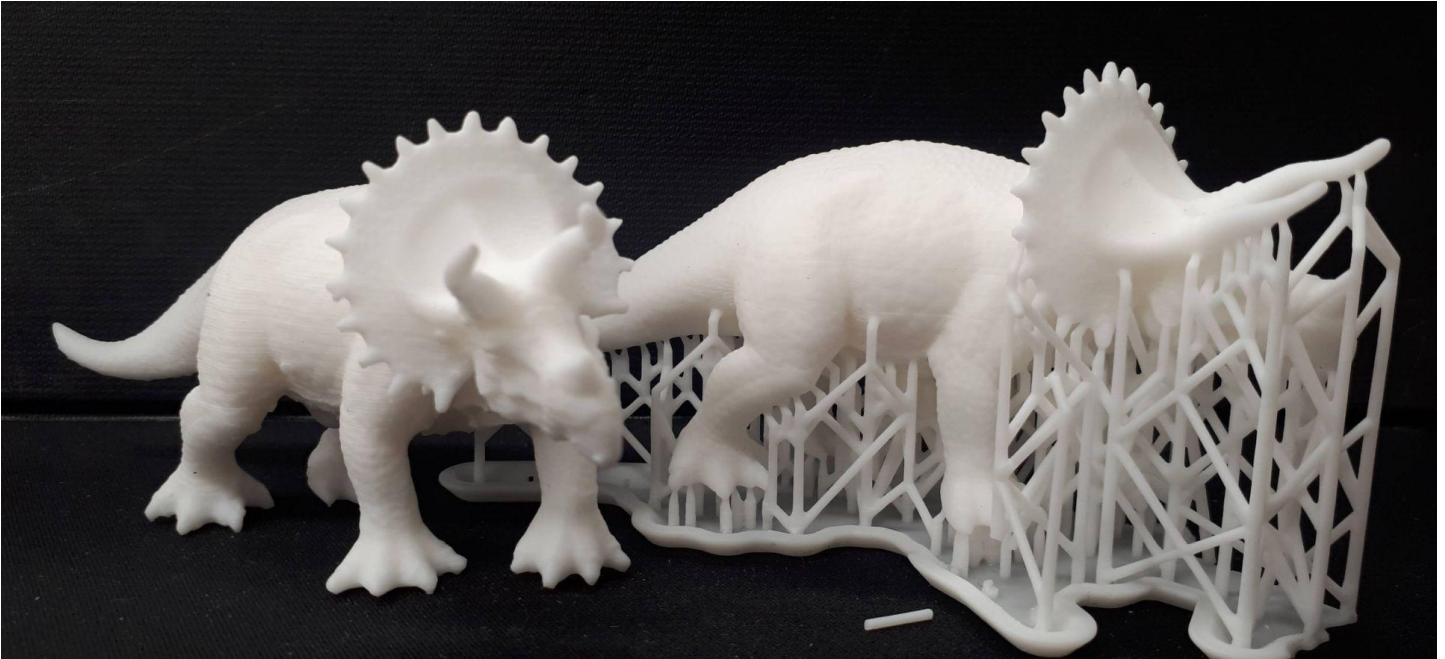

Low Resolution/Fast Print

Lower quality will print faster. Printing at a low quality increases the height of each layer of the object. This does not affect the final size of your object. Thicker layers do not allow for fine surface detail and **the layered texture is more visible.**



Choose Layer Thickness

Layer thickness affects both the speed and quality of a print. Thicker layers print faster, but sacrifice detail. Thinner layers print slower, but are able to capture finer details.



0.100 mm
Fastest



0.050 mm



0.025 mm
Finest Features

The above image shows the Lab's **SLA** print settings for low quality prints. The layer height is set to **0.1 mm**.

High Resolution/Slow Print

Higher quality will print slower. Printing at a high quality decreases the height of each layer. This does not affect the final size of your object. Thinner layers **look smoother and can be more detailed**.



Choose Layer Thickness

Layer thickness affects both the speed and quality of a print. Thicker layers print faster, but sacrifice detail. Thinner layers print slower, but are able to capture finer details.



0.100 mm
Fastest



0.050 mm



0.025 mm
Finest Features



The above image shows the Lab's **SLA** print settings for high quality prints. The layer height is set to **0.025 mm**.

SLA Supports



Flush Angle Cutters

Each new layer must be supported by the layer beneath it. If your model has overhangs which are not supported by a previous layer, there's a good chance it will print poorly. To avoid this, it is recommended to use additional 3D printed material called "supports".

Supports increase the material weight and duration of the print. They can cause little imperfections in the object's surface, and can be a hassle to remove.

The Lab recommends using "flush angle cutters" to help remove stubborn support material from SLA prints.

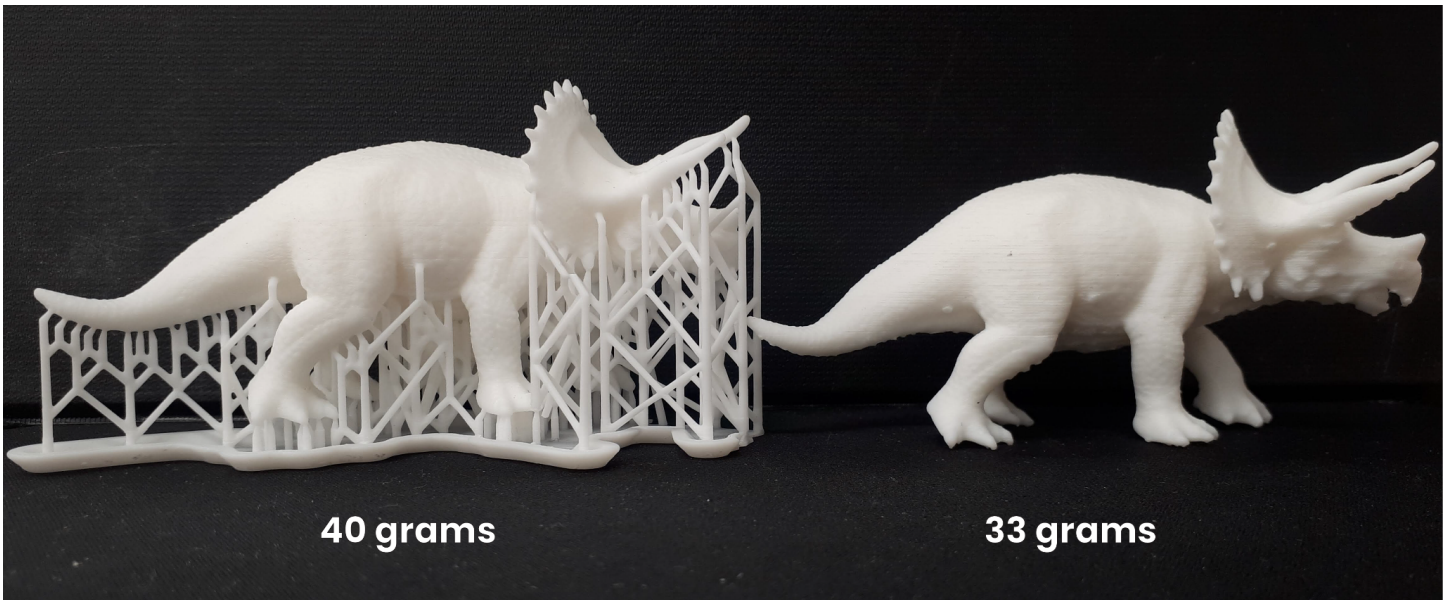

The above image compares the weight of an SLA 3D print before and after the supports are removed.

SLS Printing

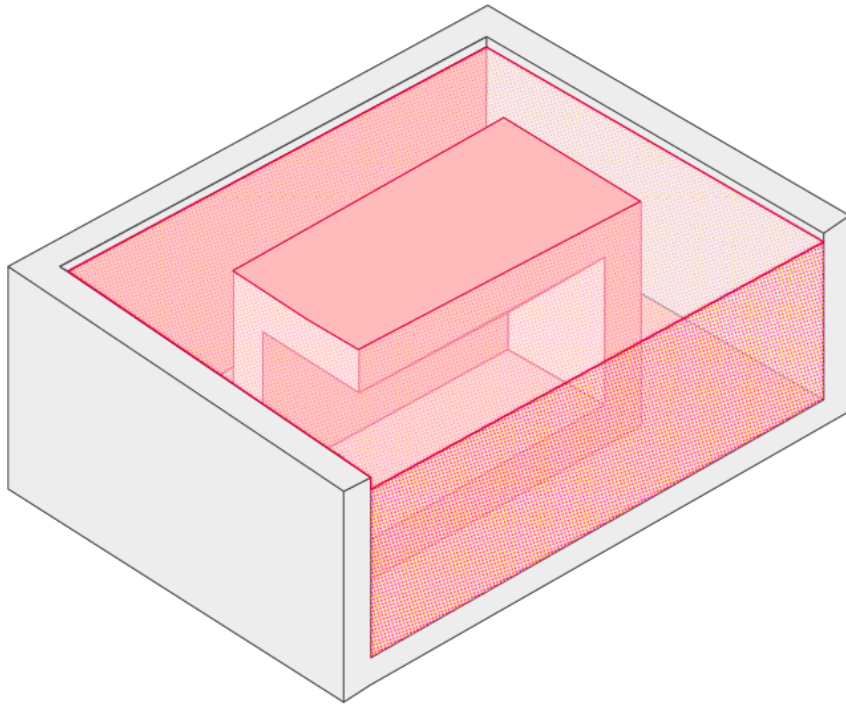

SLS Slicing Software

A **3D slicing software** is the in-between step after modeling and before printing. The slicer interprets the STL's array of polygons into printable, layered toolpaths (toolpaths = specific locations where the laser beam travels and does its thing). The slicing software can estimate the **duration of 3D printing time** and the **amount of material** that will be used.

The Design + Technology Lab's slicer of choice for our SLS printer is [PreForm](#). This slicer is free! The Lab encourages you to preview your SLS print in PreForm prior to printing to get helpful information, such as:

- Time required to complete the print
- An approximate weight of the final object
- Areas that will be too thin to print successfully (details smaller than 1mm may not print cleanly)
- Object scale (The maximum SLS printing volume is 165 x 165 x 300mm)
- The orientation of your object in relation to the print "grain" (see page 24: SLS Printability)
- "Printability" errors with your model

SLS Print Settings

Although FDM printing is cheaper and the preferred process for most models, the SLS printing technology offers a very strong, durable quality than its counterparts.

When printing using SLS technology, each consecutive layer is hardened as a solid layer, supported by unfused (loose) nylon powder. This means that the final overall 3D printed object is completely supported and solid on the interior: there are **no wall thickness, infill or support settings**. This makes the slicing process more straightforward, compared to FDM and SLA.

Applying print settings in PreForm is as simple as:

1. Choosing the printer type (the Lab uses **Fuse 1** for SLS)
2. Choosing the material type (the Lab uses **Nylon 12**)

SLS Printability

Check out [this article](#) for helpful SLS design tips!

3D printers build up prints in a series of thin *horizontal* layers. Make sure you keep this in mind when orienting your model: **critical details should be oriented parallel to the build platform**.

Estimating SLS costs in PreForm

When a model is imported, you'll be able to see the time and material details of your print. These details can be used to estimate the cost of your print (explained below).

DETAILS	
🕒 Print Time	4 h 14 min
<div style="background-color: #333; color: white; padding: 2px;"> Fused Powder: 0.13 kg Unfused Powder: 0.58 kg </div>	
📦 Total Powder	0.71 kg
📦 Packing Density	18%
📦 Layers	357

At the Lab, SLA prints are priced based on their weight. For SLS prints, the Lab charges **\$0.30 / gram** of solid fused material, plus an additional flat **\$7.00 processing fee**. The PreForm software

25

calculates the **weight (kg) of nylon powder that will be solidified** (hover your cursor over the label “Total Powder” in the Preform software for more details). You can use that approximation to estimate the print’s total cost.